



GENERATOR TYPE ECP 28-S/4

Document : **DS000A/1**
 issue 006 date 20/07/2011

Electrical Characteristics										
Frequency	Hz	50				60				
Voltage (series star)	V	380	400	415	440	415	440	460	480	
Rated power class H	kVA	17	17	17	15,5	17,5	18,6	20,4	20,4	
	kW	13,6	13,6	13,6	12,4	14	14,9	16,3	16,3	
Rated power class F	kVA	16	16	16	14,5	16,5	17,5	19	19	
	kW	12,8	12,8	12,8	11,6	13,2	14	15,2	15,2	
Regulation with	DSR	±1 % with any power factor and speed variations between -5% +30%								
Insulation class		H								
Execution		Brushless								
Stator winding		12 ends								
Rotor		without damping cage								
Efficiencies class H	4/4	%	87,1	87,2	86,9	86,7	88	88,5	88,6	88,7
(see graph. for details)	3/4	%	87,1	87,4	87,3	87	88	88,2	88,4	88,6
	2/4	%	85,3	85,4	85,4	85,1	85,9	86	86,1	86,2
	1/4	%	83,2	83,1	82,9	82,4	83,3	83,1	83,2	83,5
Reactances (f. l.cl. F)	Xd	%	217,2	196	182,1	147,7	224,9	212,7	213,4	196
	Xd'	%	18,73	16,9	15,70	12,73	19,39	18,34	18,40	16,9
	Xd''	%	12,74	11,5	10,68	8,67	13,20	12,48	12,52	11,5
	Xq	%	79,8	72	66,9	54,3	82,6	78,1	78,4	72
	Xq'	%	79,8	72	66,9	54,3	82,6	78,1	78,4	72
	Xq''	%	26,6	24	22,3	18,1	27,5	26,0	26,1	24
	X ₂	%	18,84	17	15,79	12,81	19,51	18,45	18,51	17
	X ₀	%	3,99	3,6	3,34	2,71	4,13	3,91	3,92	3,6
Short Circuit Ratio	Kcc		0,55	0,67	0,88	1,50	0,42	0,50	0,55	0,67
Time Constants	Td'	sec.	0,051							
	Td''	sec.	0,018							
	Tdo'	sec.	0,90							
	Tα	sec.	0,016							
Short Circuit Current Capacity		%	>300				>320			
Excitation at no load	Amp.		0,4	0,5	0,6	0,9	0,25	0,32	0,35	0,4
Excitation at full load	Amp.		1,7	1,7	1,9	2,1	1,3	1,5	1,6	1,7
Overload (long-term)	%	1 hour in a 6 hours period 110% rated load								
Overload per 20 sec.	%	300								
Stator Winding Resistance (20°C)	Ω	0,283								
Rotor Winding Resistance (20°C)	Ω	1,260								
Exciter Resistance (20 °C)	Ω	Rotor : 0,417				Stator : 10,60				
Heat dissipation at f.l.cl.H	W	2014	1996	2050	1902	1909	1934	2100	2079	
Telephone Interference		THF < 2 %				TIF < 45				
Radio interference		EN61000-6-3 EN61000-6-1. For others standards apply to factory								
Waveform Distors.(THD) at f. load	LL/LN %	2 / 2								
Waveform Distors.(THD) at no load	LL/LN %	3,7 / 3,7								
Mechanical characteristics										
Protection		IP 23 (other protection on request)								
DE bearing		6309-2RS								
NDE bearing		6207-2RS								
Weight of wound stator assembly	kg	33,2								
Weight of wound rotor assembly	kg	18,7								
Weight of complete generator	kg	107								
Maximun overspeed	rpm	2250								
Unbalanced magnetic pull at f.l.cl.F	kN/mm	3								
Cooling air requirement	m³/min	5,3				5,8				
Inertia Constant (H)	sec.	0,076				0,091				
Noise level at 1m/7m	dB(A)	68 / 57				71 / 61				

All technical data are to be considered as a reference and they can be modified without any notice
 This document is a propriety of Mecc Alte S.p.a..All rights reserved.



GENERATOR TYPE ECP 28-S/4

Document : DS000A/2

issue 006 date : 20/07/2011

50 Hz

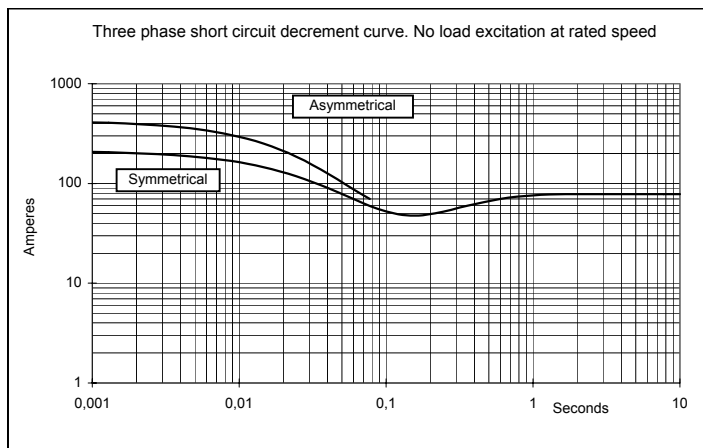
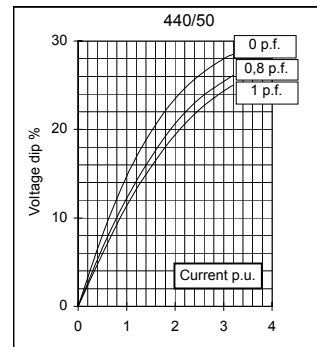
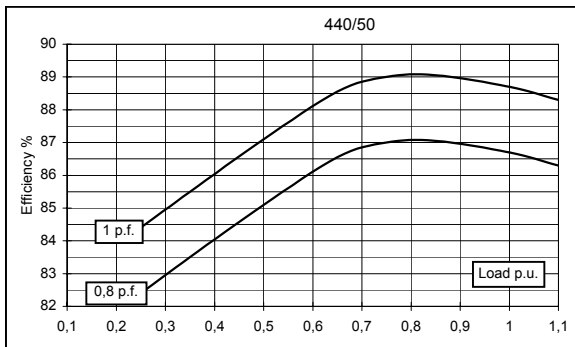
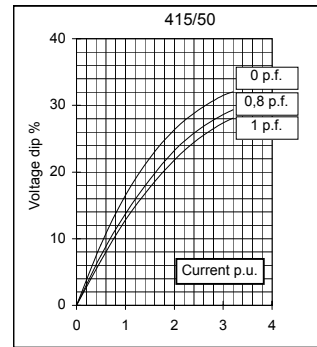
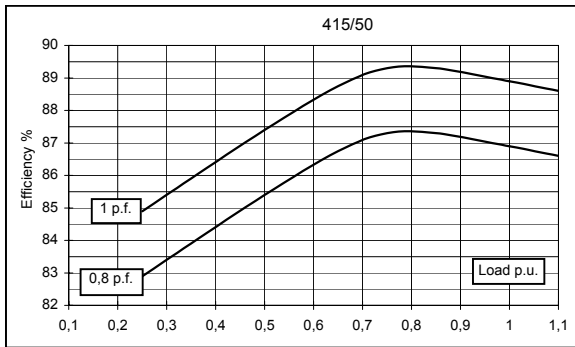
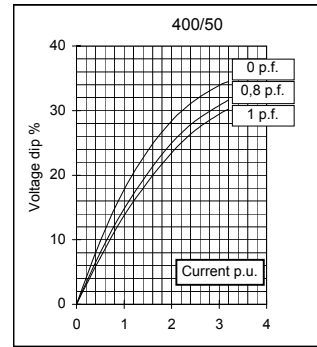
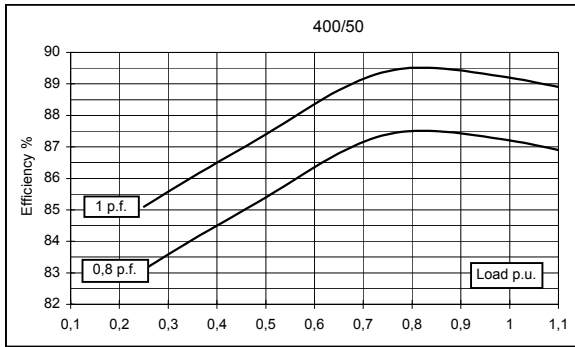
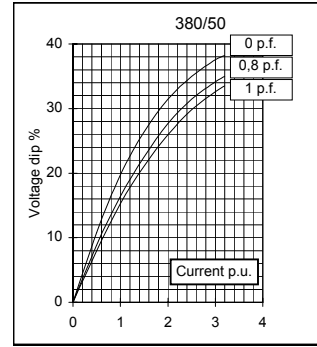
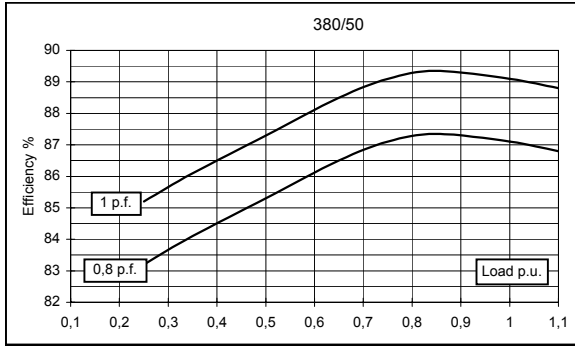

60 Hz

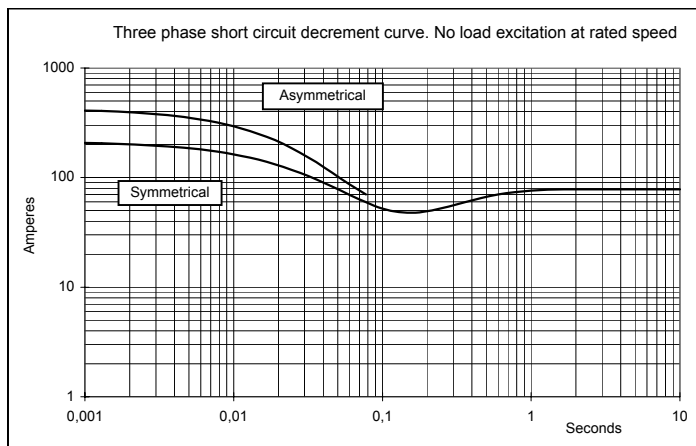
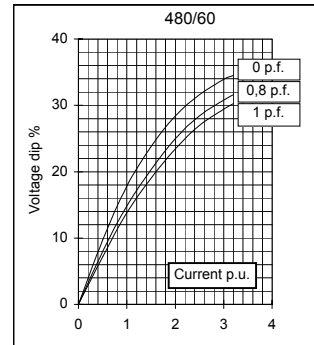
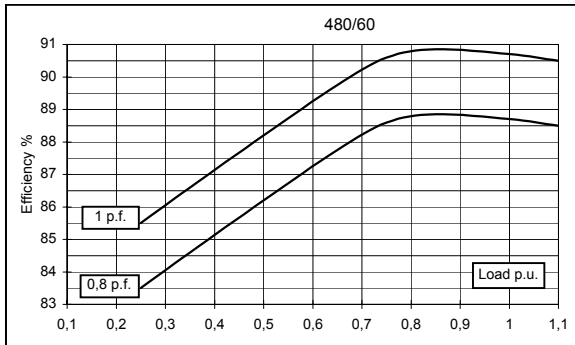
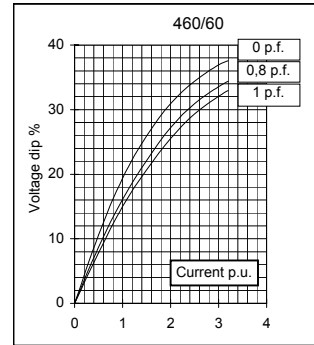
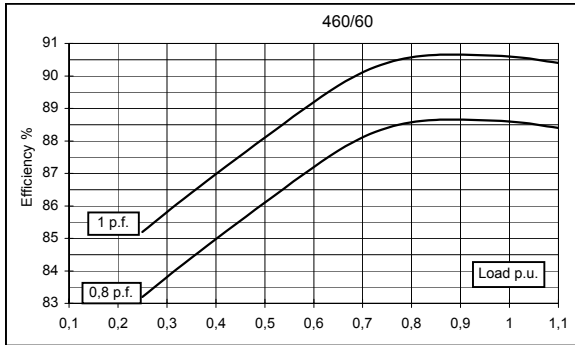
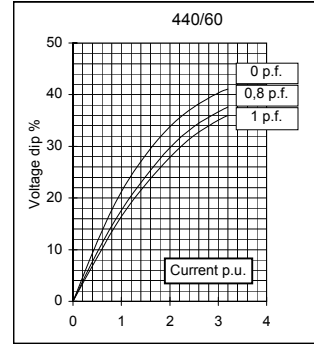
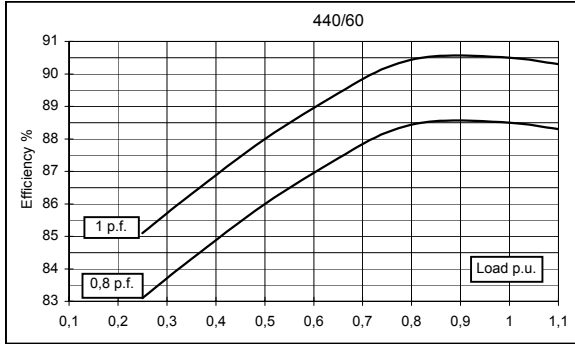
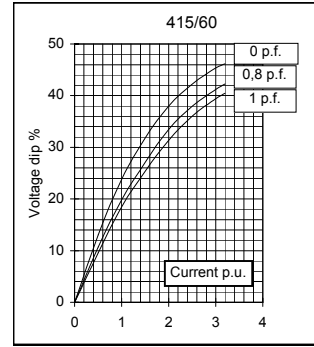
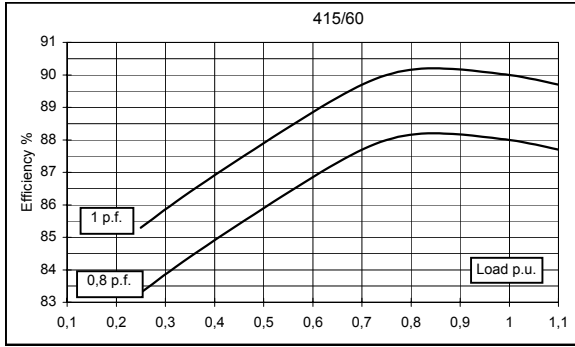

TWO BEARING MOMENTS OF INERTIA

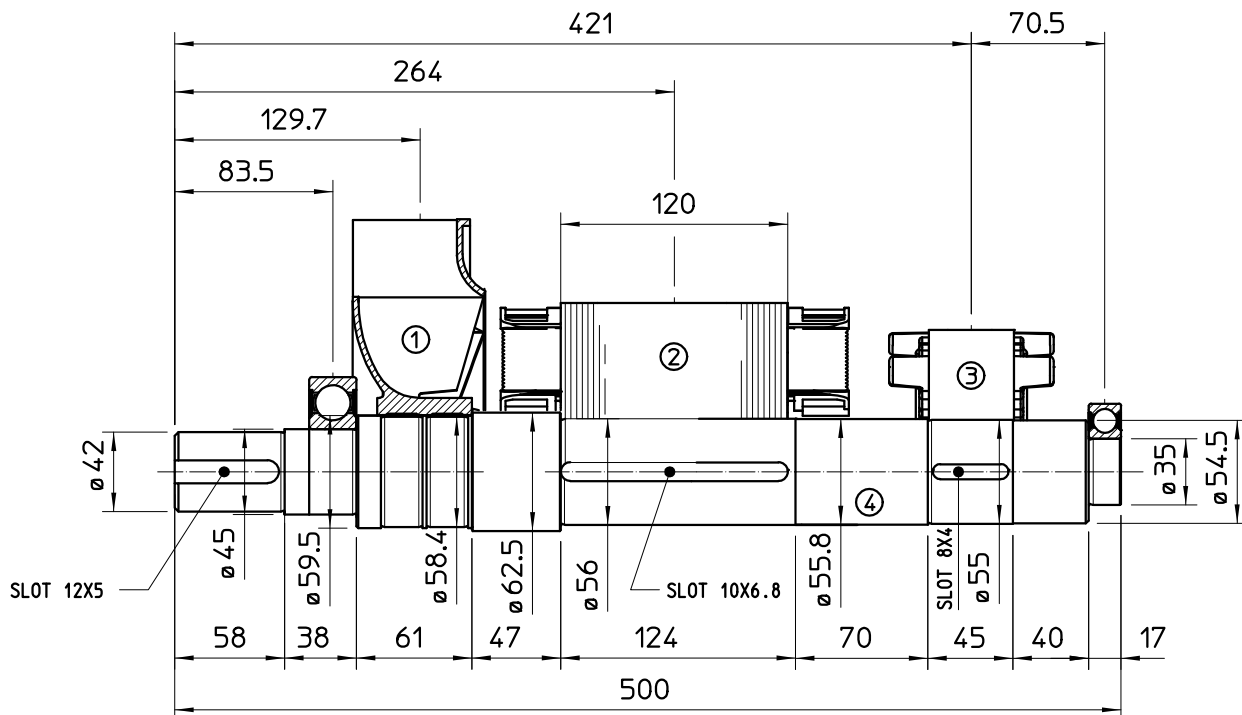

POS.	COMPONENT	WEIGHT (kg)	J (kgm ²)
1	FAN	1.2	0.0087
2	MAIN ROTOR	18.7	0.0747
3	EX. ROTOR	5.5	0.0172
4	SHAFT	8.7	0.0035
TOTAL		34.1	0.1041

TWO BEARING DIMENSIONS

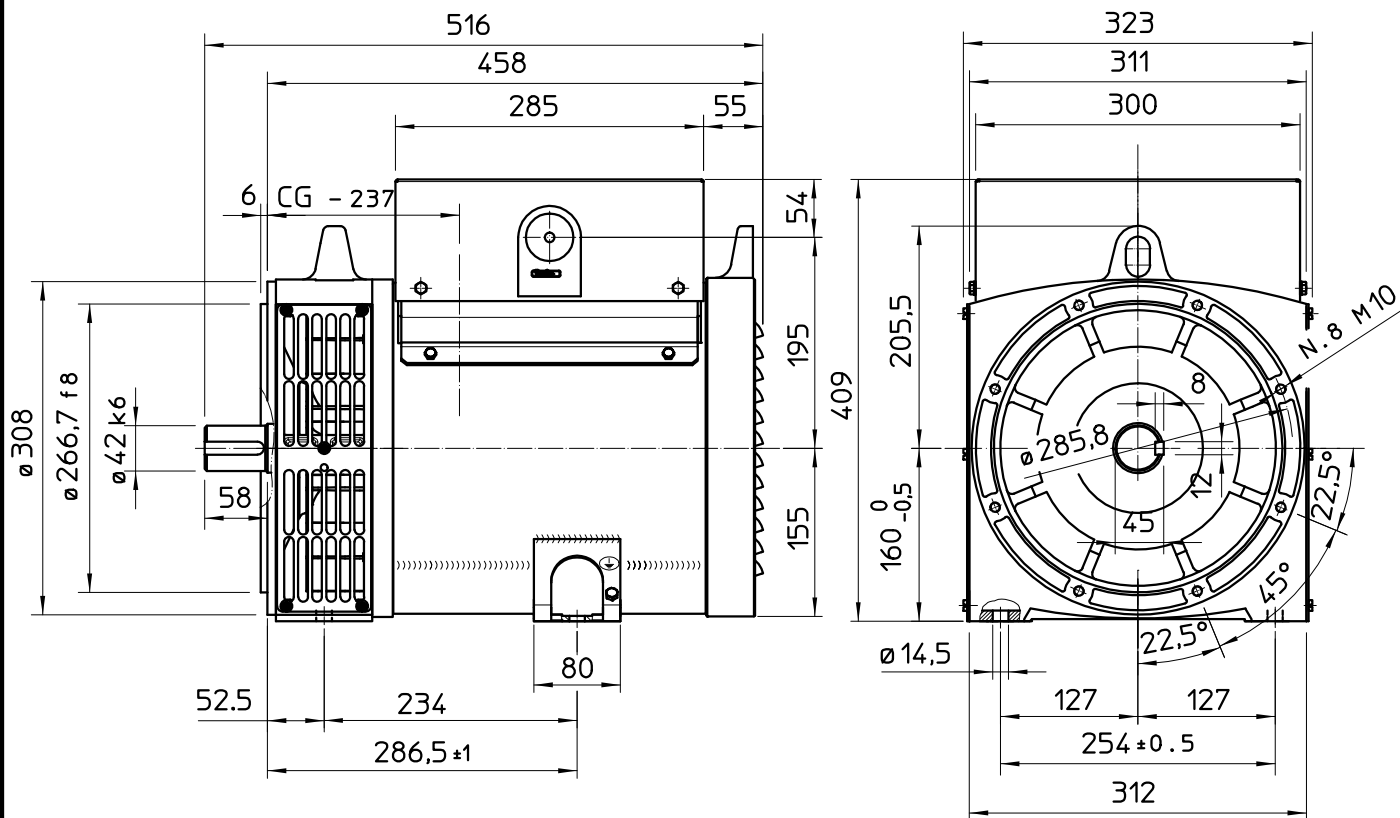

SINGLE BEARING MOMENTS OF INERTIA

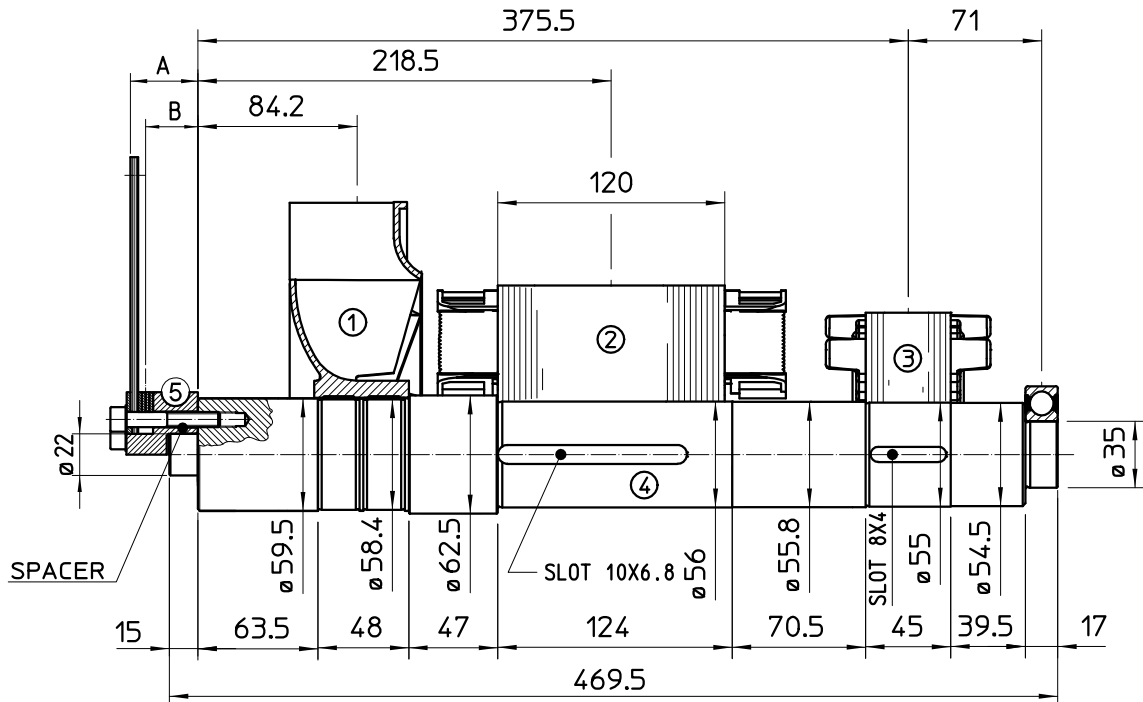

POS.	COMPONENT	WEIGHT (kg)	J (kgm ²)
1	FAN	1.2	0.0087
2	MAIN ROTOR	18.7	0.0747
3	EX. ROTOR	5.5	0.0172
4	SHAFT	8.7	0.0035
TOTAL		34.1	0.1041

SAE N°	5		SHAFTS COUPLING FLEX PLATE	
	A	B	WEIGHT kg	J kgm ²
6 1/2	4	2	1.08	0.0065
7 1/2	4	2	1.35	0.0101
8	35.6	28	2.84	0.0158
10	27.6	23	3.2	0.0303
11 1/2	14	11.2	3.6	0.0471

SINGLE BEARING DIMENSIONS

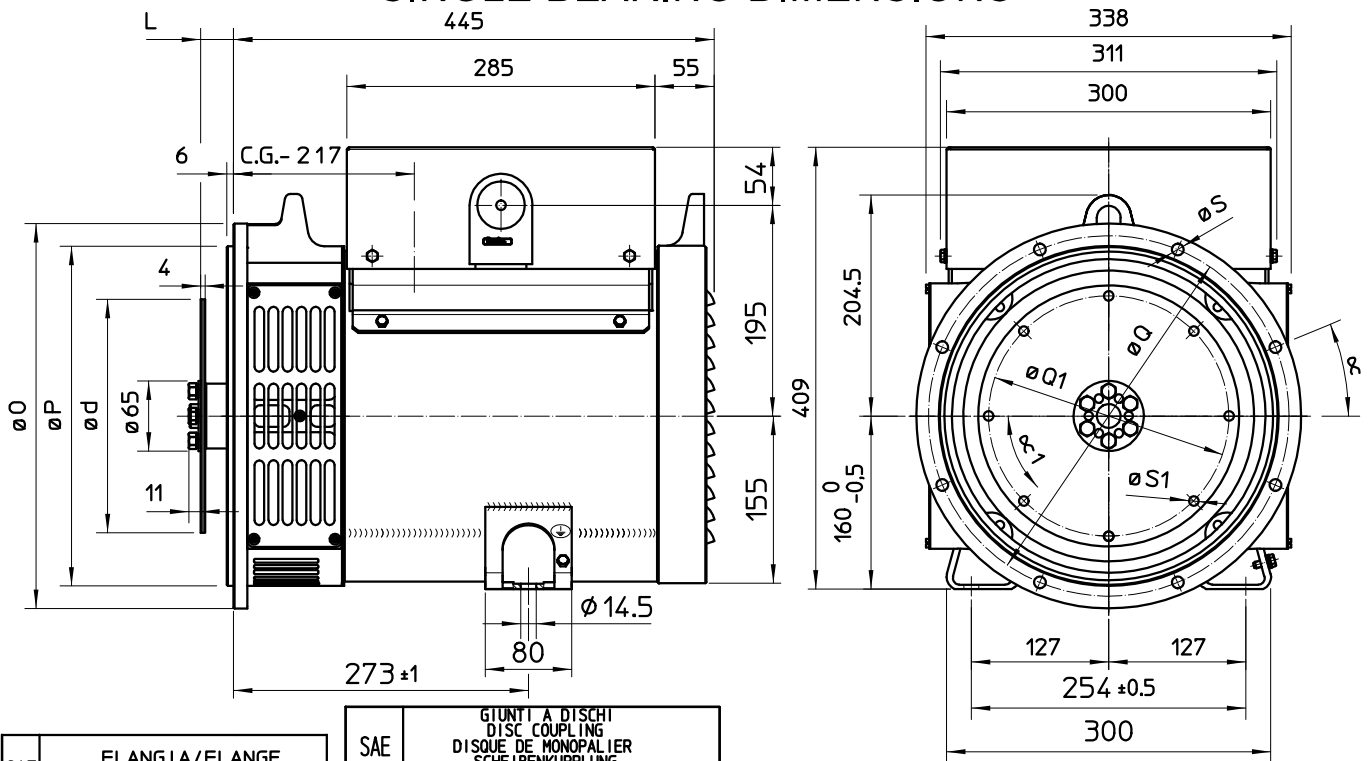

SAE N.	FLANGIA/FLANGE BRIDE/FLANSCH					
	O	P	Q	n. for i	S	α
5	356	314.3	333.4	8	11	22°30'
4	403	362	381	12	11	15°
3	451	409.6	428.6	12	11	15°
2	489	447.7	466.7	12	11	15°

SAE N.	GIUNTI A DISCHI DISC COUPLING DISQUE DE MONOPALIER SCHEIBENKUPPLUNG						
	L	d	Q1	n. for i	S1	α1	
6 1/2	30.2	215.9	200	6	9	60°	
7 1/2	30.2	241.3	222.25	8	9	45°	
8	62	263.52	244.47	6	11	60°	
10	53.8	314.32	295.27	8	11	45°	
11 1/2	39.6	352.42	333.37	8	11	45°	

C.G.= GRAVITY CENTER